



WLG4S-3F2235V

W4S-3 Inox Glass

MINIATURE PHOTOELECTRIC SENSORS

SICK
Sensor Intelligence.



Illustration may differ



Ordering information

Type	Part no.
WLG4S-3F2235V	1045098

Other models and accessories → www.sick.com/W4S-3_Inox_Glass

Detailed technical data

Features

Sensor/ detection principle	Photoelectric retro-reflective sensor, autocollimation
Dimensions (W x H x D)	15.25 mm x 44.5 mm x 22.2 mm
Housing design	Washdown
Housing design (light emission)	Rectangular
Sensing range max.	0 m ... 5 m ¹⁾
Sensing range	0 m ... 3 m ¹⁾
Type of light	Visible red light
Light source	PinPoint LED ²⁾
Light spot size (distance)	Ø 45 mm (1.5 m)
Wave length	650 nm
Adjustment	Cable ³⁾
AutoAdapt	✓
Special applications	Hygienic and washdown zones, Detecting transparent objects

¹⁾ Reflector PL80A.

²⁾ Average service life: 100,000 h at T_J = +25 °C.

³⁾ External teach-in: pulse > 2 s with voltage U_v with PNP and M with NPN.

Mechanics/electronics

Supply voltage	10 V DC ... 30 V DC ¹⁾
Ripple	< 5 V _{pp} ²⁾
Power consumption	30 mA ³⁾
Switching output	PNP
Switching mode	Dark switching
Output current I_{max.}	≤ 100 mA
Response time	< 0.5 ms ⁴⁾
Switching frequency	1,000 Hz ⁵⁾
Connection type	Male connector M8, 4-pin ⁶⁾
Circuit protection	A, B, C ^{7) 8) 9)}
Protection class	III
Weight	40 g
Polarisation filter	✓
Housing material	Stainless steel, stainless steel 316L
Enclosure rating	IP66, IP67, IP68, IP69K ¹⁰⁾
Special feature	Detecting transparent objects
Ambient operating temperature	-30 °C ... +70 °C ¹¹⁾ -30 °C ... +60 °C
Ambient storage temperature	-30 °C ... +75 °C
UL File No.	NRKH.E181493 & NRKH7.E181493

¹⁾ Limit values, reverse-polarity protected, operation in short-circuit protected network: max. 8 A.

²⁾ May not exceed or fall below U_v tolerances.

³⁾ Without load.

⁴⁾ Signal transit time with resistive load.

⁵⁾ With light/dark ratio 1:1.

⁶⁾ Max. tightening torque: 0.6 Nm.

⁷⁾ A = V_S connections reverse-polarity protected.

⁸⁾ B = inputs and output reverse-polarity protected.

⁹⁾ C = interference suppression.

¹⁰⁾ Only in case of correctly mounted IP69K connecting cable.

¹¹⁾ At UV ≤ 24 V and IA < 30 mA.

Safety-related parameters

MTTF_D	1,232 years
DC_{avg}	0%

Classifications

ECI@ss 5.0	27270902
ECI@ss 5.1.4	27270902
ECI@ss 6.0	27270902
ECI@ss 6.2	27270902
ECI@ss 7.0	27270902
ECI@ss 8.0	27270902
ECI@ss 8.1	27270902

ECl@ss 9.0	27270902
ETIM 5.0	EC002717
ETIM 6.0	EC002717
UNSPSC 16.0901	39121528

Connection diagram

Cd-092

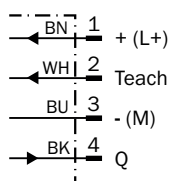

Characteristic curve

WL4S-3, WLG4S-3, 5 m

Operating reserve

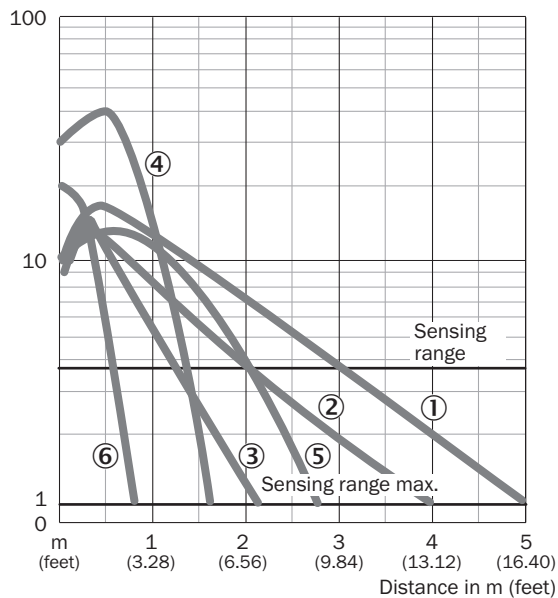

- ① Reflector PL80A
- ② Reflector PL40A
- ③ Reflector PL20A
- ④ PL10F reflector
- ⑤ Reflector P250 CHEM
- ⑥ Reflective tape REF-IRF-56

Sensing range diagram

WL4S-3, WLG4S-3, 5 m

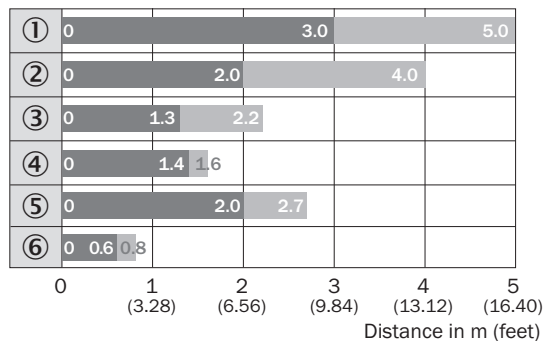

■ Sensing range ■ Sensing range max.

- ① Reflector PL80A
- ② Reflector PL40A
- ③ Reflector PL20A
- ④ PL10F reflector
- ⑤ Reflector P250 CHEM
- ⑥ Reflective tape REF-IRF-56

Dimensional drawing (Dimensions in mm (inch))

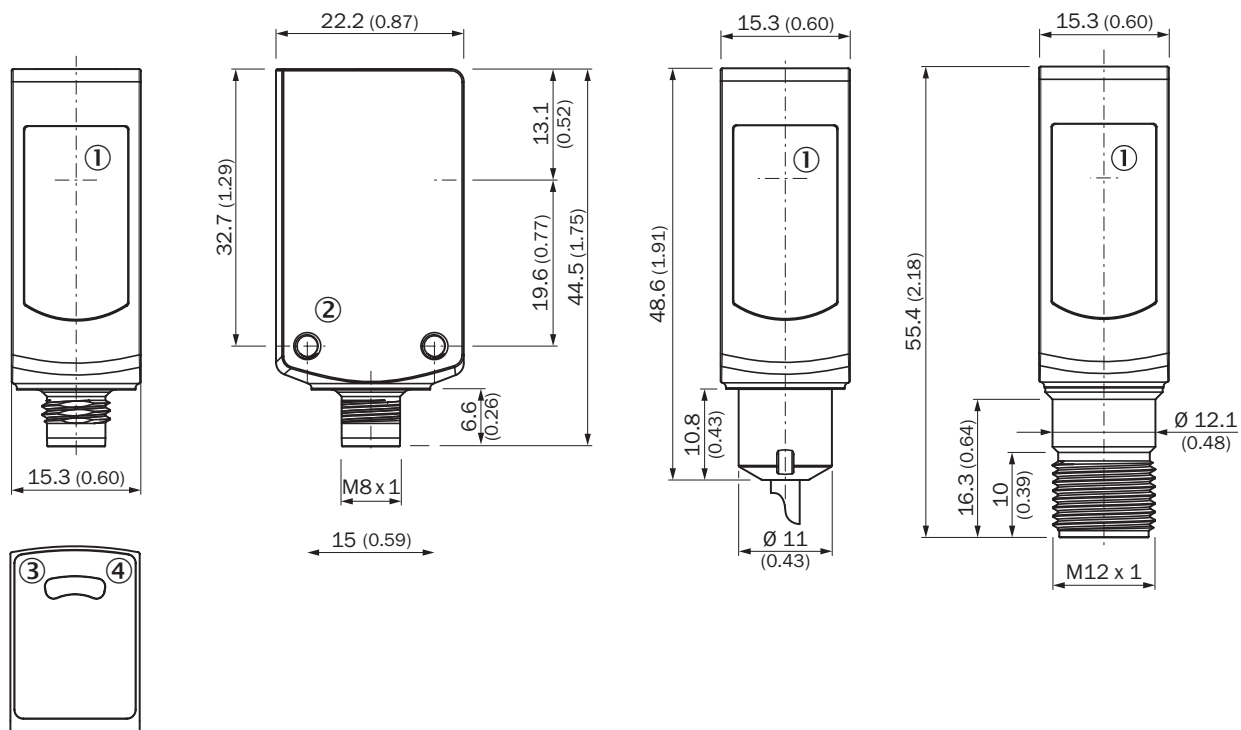

WL4S-3V, WLG4S-3V, without single teach-in button



- ① Center of optical axis
- ② Threaded mounting hole M3
- ③ LED indicator yellow: Status of received light beam
- ④ LED indicator green: Supply voltage active

Recommended accessories

Other models and accessories → www.sick.com/W4S-3_Inox_Glass

	Brief description	Type	Part no.
Mounting brackets and plates			
	Mounting bracket for floor mounting, Stainless steel 1.4571, mounting hardware included	BEF-W4-B	2051630
Plug connectors and cables			
	Head A: female connector, M8, 4-pin, straight Head B: Flying leads Cable: PVC, unshielded, 5 m This product is generally resistant to chemical cleaning agents (see ECOLAB). Please do not use cleaning agents of any other Kind., Not resistant against lactic acid & hydrogen peroxide (H2O2)	DOL-0804-G05MNI	6059194
Reflectors			
	Fine triple reflector, screw connection, suitable for laser sensors, 18 mm x 18 mm, PM-MA/ABS, Screw-on, 2 hole mounting	PL10F	5311210

SICK AT A GLANCE

SICK is one of the leading manufacturers of intelligent sensors and sensor solutions for industrial applications. A unique range of products and services creates the perfect basis for controlling processes securely and efficiently, protecting individuals from accidents and preventing damage to the environment.

We have extensive experience in a wide range of industries and understand their processes and requirements. With intelligent sensors, we can deliver exactly what our customers need. In application centers in Europe, Asia and North America, system solutions are tested and optimized in accordance with customer specifications. All this makes us a reliable supplier and development partner.

Comprehensive services complete our offering: SICK LifeTime Services provide support throughout the machine life cycle and ensure safety and productivity.

For us, that is “Sensor Intelligence.”

WORLDWIDE PRESENCE:

Contacts and other locations –www.sick.com