



WL4S-3P2130

W4S-3

MINIATURE PHOTOELECTRIC SENSORS

SICK
Sensor Intelligence.



Illustration may differ



Ordering information

| Type | Part no. |
|-------------|----------|
| WL4S-3P2130 | 1042069 |

Other models and accessories → www.sick.com/W4S-3

Detailed technical data

Features

| | |
|--|--|
| Sensor/ detection principle | Photoelectric retro-reflective sensor, autocollimation |
| Dimensions (W x H x D) | 12.2 mm x 41.8 mm x 17.3 mm |
| Housing design (light emission) | Rectangular |
| Sensing range max. | 0 m ... 4 m ¹⁾ |
| Sensing range | 0 m ... 2.5 m ¹⁾ |
| Type of light | Visible red light |
| Light source | PinPoint LED ²⁾ |
| Light spot size (distance) | Ø 45 mm (1.5 m) |
| Wave length | 650 nm |
| Adjustment | None |

¹⁾ Reflector PL80A.

²⁾ Average service life: 100,000 h at T_U = +25 °C.

Mechanics/electronics

| | |
|--|---|
| Supply voltage | 10 V DC ... 30 V DC ¹⁾ |
| Ripple | < 5 V _{pp} ²⁾ |
| Power consumption | 20 mA ³⁾ |
| Switching output | PNP |
| Switching mode | Light switching |
| Output current I_{max.} | ≤ 100 mA |
| Response time | < 0.5 ms ⁴⁾ |
| Switching frequency | 1,000 Hz ⁵⁾ |
| Connection type | Connector M8, 3-pin |
| Circuit protection | A ⁶⁾ C ⁷⁾ D ⁸⁾ |
| Protection class | III |
| Weight | 30 g |
| Polarisation filter | ✓ |
| Housing material | Plastic, ABS |
| Optics material | Plastic, PMMA |
| Enclosure rating | IP67 IP66 |
| Ambient operating temperature | -40 °C ... +60 °C |
| Ambient storage temperature | -40 °C ... +75 °C |
| UL File No. | NRKH.E181493 & NRKH7.E181493 |

¹⁾ Limit values.

²⁾ May not exceed or fall below U_v tolerances.

³⁾ Without load.

⁴⁾ Signal transit time with resistive load.

⁵⁾ With light/dark ratio 1:1.

⁶⁾ A = V_S connections reverse-polarity protected.

⁷⁾ C = interference suppression.

⁸⁾ D = outputs overcurrent and short-circuit protected.

Safety-related parameters

| | |
|-------------------------|-------------|
| MTTF_D | 1,967 years |
| DC_{avg} | 0% |

Classifications

| | |
|---------------------|----------|
| ECl@ss 5.0 | 27270902 |
| ECl@ss 5.1.4 | 27270902 |
| ECl@ss 6.0 | 27270902 |
| ECl@ss 6.2 | 27270902 |
| ECl@ss 7.0 | 27270902 |
| ECl@ss 8.0 | 27270902 |
| ECl@ss 8.1 | 27270902 |
| ECl@ss 9.0 | 27270902 |

| | |
|-----------------------|----------|
| ETIM 5.0 | EC002717 |
| ETIM 6.0 | EC002717 |
| UNSPSC 16.0901 | 39121528 |

Connection diagram

Cd-045

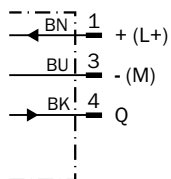

Characteristic curve

WL4S-3

Operating reserve

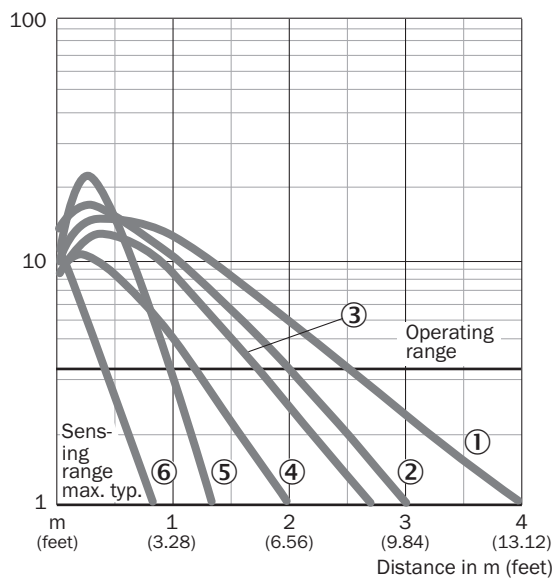

- ① Reflector PL80A
- ② Reflector P250F
- ③ Reflector PL40A
- ④ Reflector PL20F
- ⑤ PL10F reflector
- ⑥ Reflective tape REF-IRF-56

Light spot size

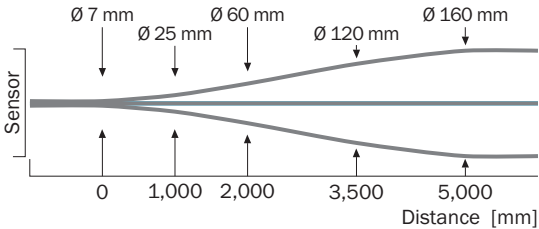

Sensing range diagram

WL4S-3, WLG4S-3, 4 m

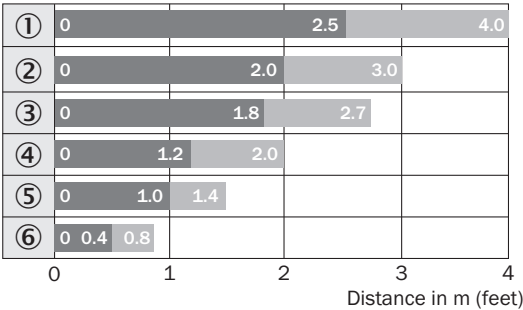

- Sensing range
- Sensing range max.
- ① Reflector PL80A
- ② Reflector P250F
- ③ Reflector PL40A
- ④ Reflector PL20F
- ⑤ PL10F reflector
- ⑥ Reflective tape REF-IRF-56

Dimensional drawing (Dimensions in mm (inch))



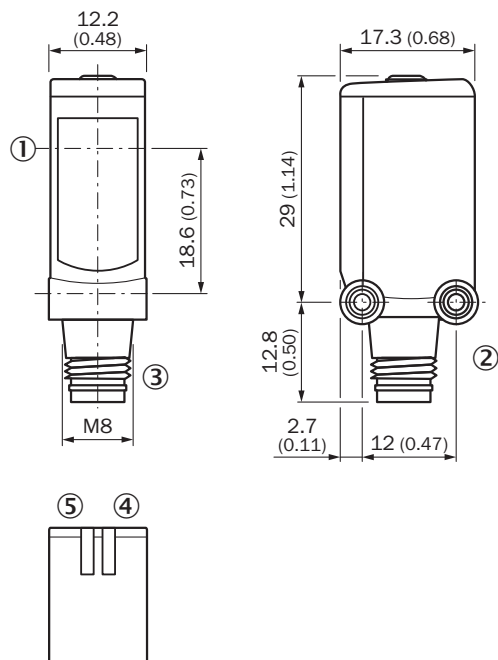

WL4S-3, WSE4S-3, potentiometer



- ① Center of optical axis
- ② Threaded mounting hole M3
- ③ Connection
- ④ LED indicator green: Supply voltage active
- ⑤ LED indicator yellow: Status of received light beam

Recommended accessories

Other models and accessories → www.sick.com/W4S-3

| | Brief description | Type | Part no. |
|---|--|--------------------|----------|
| Mounting brackets and plates | | | |
|  | Mounting bracket for wall mounting, Stainless steel 1.4571, mounting hardware included | BEF-W4-A | 2051628 |
| Plug connectors and cables | | | |
|  | Head A: female connector, M8, 3-pin, straight, A-coded Head B: Flying leads Cable: Sensor/actuator cable, PVC, unshielded, 5 m | YF8U13-050VA1XLEAX | 2095884 |
|  | Head A: male connector, M8, 3-pin, straight Head B: - Cable: unshielded | STE-0803-G | 6037322 |
| Reflectors | | | |
|  | Fine triple reflector, screw connection, suitable for laser sensors, 18 mm x 18 mm, PM-MA/ABS, Screw-on, 2 hole mounting | PL10F | 5311210 |

SICK AT A GLANCE

SICK is one of the leading manufacturers of intelligent sensors and sensor solutions for industrial applications. A unique range of products and services creates the perfect basis for controlling processes securely and efficiently, protecting individuals from accidents and preventing damage to the environment.

We have extensive experience in a wide range of industries and understand their processes and requirements. With intelligent sensors, we can deliver exactly what our customers need. In application centers in Europe, Asia and North America, system solutions are tested and optimized in accordance with customer specifications. All this makes us a reliable supplier and development partner.

Comprehensive services complete our offering: SICK LifeTime Services provide support throughout the machine life cycle and ensure safety and productivity.

For us, that is “Sensor Intelligence.”

WORLDWIDE PRESENCE:

Contacts and other locations –www.sick.com