



LMS100-10000

LMS1xx

2D LIDAR SENSORS

SICK
Sensor Intelligence.



Ordering information

Type	Part no.
LMS100-10000	1041113

Other models and accessories → www.sick.com/LMS1xx



Detailed technical data

Features

Application	Indoor
Light source	Infrared (905 nm)
Laser class	1 (IEC 60825-1:2014, EN 60825-1:2014)
Aperture angle	Horizontal 270°
Scanning frequency	25 Hz / 50 Hz
Angular resolution	0.25° 0.5°
Heating	No
Working range	0.5 m ... 20 m
Scanning range	At 10% remission 18 m At 90% remission 20 m
Amount of evaluated echoes	2
Fog correction	Yes

Mechanics/electronics

Electrical connection	1 x system plug with screw terminal block
Supply voltage	10.8 V DC ... 30 V DC
Power consumption	Typ. 8 W
Housing color	Light blue (RAL 5012)
Enclosure rating	IP65 (EN 60529, Section 14.2.5)
Protection class	III (EN 50178 (1997;10))
Weight	1.1 kg
Dimensions (L x W x H)	105 mm x 102 mm x 152 mm

Performance

Response time	≥ 20 ms
Detectable object shape	Almost any
Systematic error	± 30 mm ¹⁾
Statistical error	12 mm ¹⁾
Integrated application	Field evaluation with flexible fields
Number of field sets	10 fields
Simultaneous evaluation cases	10

¹⁾ Typical value; actual value depends on environmental conditions.

Interfaces

Ethernet	✓, TCP/IP
Remark	OPC
Function	Host
Data transmission rate	10/100 MBit/s
Serial	✓, RS-232
Function	Host, AUX
Data transmission rate	9.6 kBaud ... 115.2 kBaud
CAN	✓
Function	Extension of outputs
Digital inputs	2 digital and 2 encoder inputs
Digital outputs	3
Optical indicators	7-segment display (plus 5 LEDs showing device status, contamination warning and initial condition)

Ambient data

Object remission	2 % ... > 1,000 % (reflectors)
Electromagnetic compatibility (EMC)	EN 61000-6-2:2005 / EN 61000-6-4 (2007-01)
Vibration resistance	EN 60068-2-6 (1995-04)
Shock resistance	EN 60068-2-27 (1993-03)
Ambient operating temperature	0 °C ... +50 °C
Storage temperature	-30 °C ... +70 °C
Ambient light immunity	40,000 lx

General notes

Note on use	The sensor does not constitute a safety component as defined by relevant legislation on machine safety.
--------------------	---

Classifications

ECl@ss 5.0	27270990
ECl@ss 5.1.4	27270990
ECl@ss 6.0	27270913
ECl@ss 6.2	27270913
ECl@ss 7.0	27270913
ECl@ss 8.0	27270913

ECI@ss 8.1	27270913
ECI@ss 9.0	27270913
ETIM 5.0	EC002550
ETIM 6.0	EC002550
UNSPSC 16.0901	46171620

Dimensional drawing (Dimensions in mm (inch))

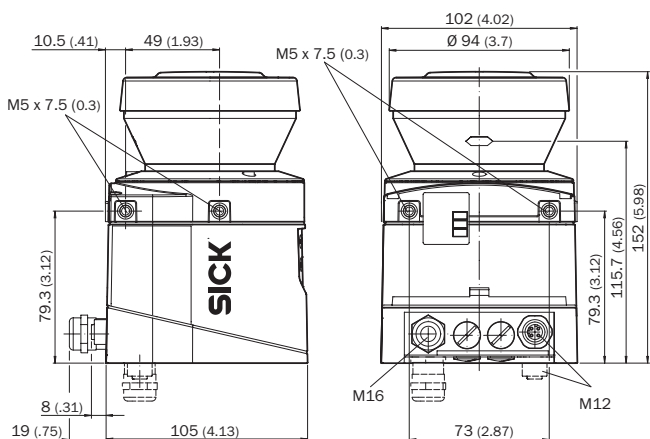

Working range diagram

Scanning range in m (ft)

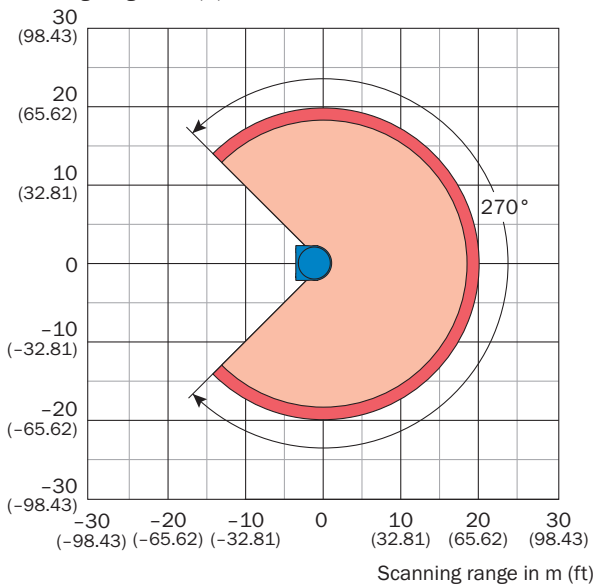

Connection type

Ethernet

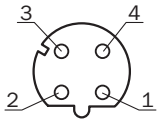

M12 female connector, 4-pin, D-coded

- ① TX+
- ② RX+
- ③ TX-
- ④ RX-

PIN assignment

AUX

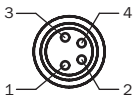





Female connector M8, 4-pin

- ① Reserved
- ② RxD AUX
- ③ GND RS
- ④ TxD AUX

Recommended accessories

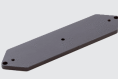
Other models and accessories → www.sick.com/LMS1xx

	Brief description	Type	Part no.
Mounting brackets and plates			
	1 piece, mounting bracket for rear mounting on wall or machine	Mounting kit 1a	2034324
	1 piece, mounting bracket for rear mounting on wall or machine with protection of optics hood	Mounting kit 1b	2034325
	1 piece, mounting bracket, adjustable lateral axis, only in conjunction with mounting kit 1a (2034324) or 1b (2034325)	Mounting kit 2	2039302
	1 piece, mounting plate, adjustable longitudinal axis, only in conjunction with mounting kit 2 (2039302)	Mounting kit 3	2039303
Plug connectors and cables			
	Head A: Flying leads Head B: Flying leads Cable: PVC, unshielded On 100 m reel	Connecting cable	6030795
	Head A: male connector, M12, 4-pin, straight, D-coded Head B: male connector, RJ45, 8-pin, straight Cable: Ethernet, twisted pair, PUR, halogen-free, shielded, 5 m	YM2D24-050EA1MRJA4	6034415

Recommended services

Additional services → www.sick.com/LMS1xx

	Type	Part no.
Warranty extensions		
<ul style="list-style-type: none"> • Product area: Identification solutions, Vision, Distance sensors, Detection and ranging solutions • Range of services: The services correspond to the scope of the statutory manufacturer warranty (SICK general terms and conditions of purchase), Long-term protection for calculable lump sum. • Duration: Five-year warranty from date of purchase. 	Five-year extended warranty	1680671
Training		
<ul style="list-style-type: none"> • Product family group: 2D LiDAR sensors, 3D LiDAR sensors • Range of services: The training format and location can be worked out in collaboration with SICK • Note: A minimum and maximum number of participants is determined based on the training format, depending on the training format, content and location, a training course may take place over the course of one or more work days • Duration: The fixed price includes the specific training services agreed upon with the customer, the fixed price includes the work time required for the training services, the required work time depends on the range of services, Additional work will be invoiced separately based on time spent • Travel expenses: The prices include costs for the travel time and expensestravel costs, such as flight or hotel expenses, are not included 	Training LMS/MRS/NAV/TiM	1612234
Commissioning		
<ul style="list-style-type: none"> • Product area: 2D LiDAR sensors, 3D LiDAR sensors • Range of services: Inspection of connection, fine adjustment, configuration of monitored areas, configuration and optimization of parameters of the LMS/MRS/NAV/TiM as well as verification tests, Setup of previously defined functions of basic settings, parameters of field application, filters for raw data output and product-specific configuration • Documentation: Archiving of product parameters in a SICK database, Documentation of performance, Creation of a commissioning log • Duration: Additional work will be invoiced separately based on time spent • Note: The prices do not include expenses or costs for the travel time 	Commissioning LMS/MRS/NAV/TiM (Prime package)	1680672
Maintenance		
<ul style="list-style-type: none"> • Product area: 2D LiDAR sensors, 3D LiDAR sensors • Range of services: Inspection, analysis and restoring of defined functions, Inspection and adaptation of basic settings, parameters of field application, filters for raw data output, and product-specific configuration • Documentation: Documentation of operating hours and archiving of parameters in a SICK database, Creation of a maintenance log • Duration: Additional work will be invoiced separately based on time spent • Note: The prices do not include expenses or costs for the travel time 	Maintenance LMS/MRS/NAV/TiM	1682593

SICK AT A GLANCE

SICK is one of the leading manufacturers of intelligent sensors and sensor solutions for industrial applications. A unique range of products and services creates the perfect basis for controlling processes securely and efficiently, protecting individuals from accidents and preventing damage to the environment.

We have extensive experience in a wide range of industries and understand their processes and requirements. With intelligent sensors, we can deliver exactly what our customers need. In application centers in Europe, Asia and North America, system solutions are tested and optimized in accordance with customer specifications. All this makes us a reliable supplier and development partner.

Comprehensive services complete our offering: SICK LifeTime Services provide support throughout the machine life cycle and ensure safety and productivity.

For us, that is “Sensor Intelligence.”

WORLDWIDE PRESENCE:

Contacts and other locations –www.sick.com