



WSE4-3P2130

W4-3

MINIATURE PHOTOELECTRIC SENSORS

SICK
Sensor Intelligence.



Illustration may differ



Ordering information

Type	Part no.
WSE4-3P2130	1028163

Other models and accessories → www.sick.com/W4-3

Detailed technical data

Features

Sensor/ detection principle	Through-beam photoelectric sensor
Dimensions (W x H x D)	16 mm x 39.5 mm x 12 mm
Housing design (light emission)	Rectangular
Sensing range max.	0 m ... 4 m
Sensing range	0 m ... 3.5 m
Type of light	Visible red light
Light source	PinPoint LED ¹⁾
Light spot size (distance)	Ø 75 mm (2 m)
Wave length	650 nm
Adjustment	None

¹⁾ Average service life: 100,000 h at T_U = +25 °C.

Mechanics/electronics

Supply voltage	10 V DC ... 30 V DC ¹⁾
-----------------------	-----------------------------------

- ¹⁾ Limit values.
- ²⁾ May not exceed or fall below U_v tolerances.
- ³⁾ Sender.
- ⁴⁾ Signal transit time with resistive load.
- ⁵⁾ With light/dark ratio 1:1.
- ⁶⁾ A = V_S connections reverse-polarity protected.
- ⁷⁾ C = interference suppression.
- ⁸⁾ D = outputs overcurrent and short-circuit protected.

Ripple	< 5 V _{pp} ²⁾
Power consumption	20 mA ³⁾
Switching output	PNP
Switching mode	Light switching
Output current I_{max}	≤ 100 mA
Response time	< 0.5 ms ⁴⁾
Switching frequency	1,000 Hz ⁵⁾
Connection type	Connector M8, 3-pin
Circuit protection	A ⁶⁾ C ⁷⁾ D ⁸⁾
Protection class	III
Weight	60 g
Housing material	Plastic, ABS
Optics material	Plastic, PMMA
Enclosure rating	IP67 IP66
Test input sender off	TE to 0 V
Ambient operating temperature	-40 °C ... +60 °C
Ambient storage temperature	-40 °C ... +75 °C
UL File No.	NRKH.E181493 & NRKH7.E181493
Part number of individual components	2039061 WS4-3D2130 2039067 WE4-3P2130

1) Limit values.

2) May not exceed or fall below U_v tolerances.

3) Sender.

4) Signal transit time with resistive load.

5) With light/dark ratio 1:1.

6) A = V_S connections reverse-polarity protected.

7) C = interference suppression.

8) D = outputs overcurrent and short-circuit protected.

Safety-related parameters

MTTF_D	1,138 years
DC_{avg}	0%

Classifications

ECl@ss 5.0	27270901
ECl@ss 5.1.4	27270901
ECl@ss 6.0	27270901
ECl@ss 6.2	27270901
ECl@ss 7.0	27270901
ECl@ss 8.0	27270901
ECl@ss 8.1	27270901
ECl@ss 9.0	27270901
ETIM 5.0	EC002716

ETIM 6.0	EC002716
UNSPSC 16.0901	39121528

Connection diagram

Connection diagram

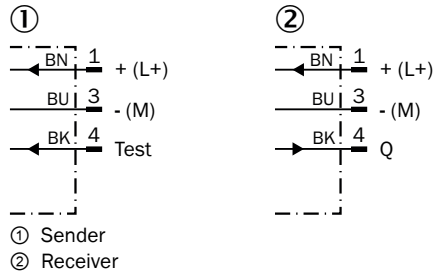

Characteristic curve

WSE4-3

Operating reserve

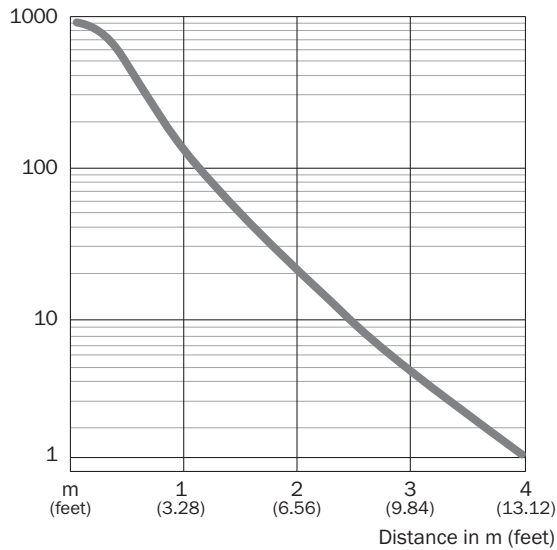

Sensing range diagram

WSE4-3

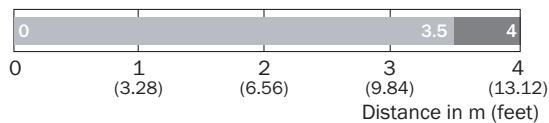

■ Sensing range typ. max ■ Sensing range

Dimensional drawing (Dimensions in mm (inch))

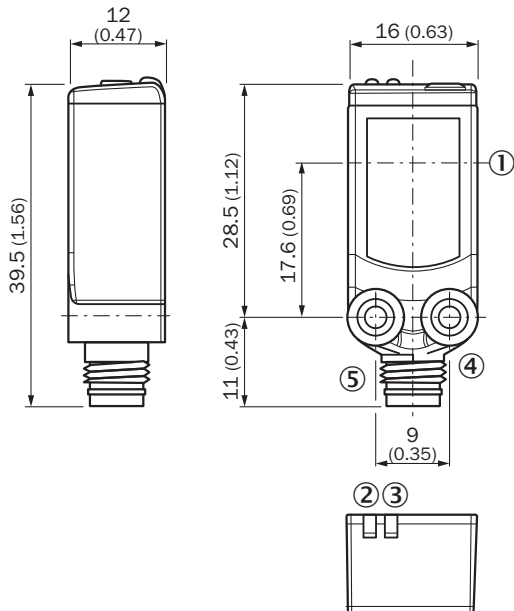

WSE4-3



- ① Center of optical axis
- ② Orange LED indicator: status of received light beam
- ③ LED indicator green: Supply voltage active
- ④ Threaded mounting hole M3
- ⑤ Connection

Recommended accessories

Other models and accessories → www.sick.com/W4-3

	Brief description	Type	Part no.
Universal bar clamp systems			
	Plate N08 for universal clamp bracket, Zinc plated steel (sheet), Zinc die cast (clamping bracket), Universal clamp (5322626), mounting hardware	BEF-KHS-N08	2051607
Plug connectors and cables			
	Head A: female connector, M8, 3-pin, straight, A-coded Head B: Flying leads Cable: Sensor/actuator cable, PVC, unshielded, 5 m	YF8U13-050VA1XLEAX	2095884
	Head A: male connector, M8, 3-pin, straight Head B: - Cable: unshielded	STE-0803-G	6037322

SICK AT A GLANCE

SICK is one of the leading manufacturers of intelligent sensors and sensor solutions for industrial applications. A unique range of products and services creates the perfect basis for controlling processes securely and efficiently, protecting individuals from accidents and preventing damage to the environment.

We have extensive experience in a wide range of industries and understand their processes and requirements. With intelligent sensors, we can deliver exactly what our customers need. In application centers in Europe, Asia and North America, system solutions are tested and optimized in accordance with customer specifications. All this makes us a reliable supplier and development partner.

Comprehensive services complete our offering: SICK LifeTime Services provide support throughout the machine life cycle and ensure safety and productivity.

For us, that is “Sensor Intelligence.”

WORLDWIDE PRESENCE:

Contacts and other locations –www.sick.com