



# WLG4-3F2182

W4-3 Glass

MINIATURE PHOTOELECTRIC SENSORS

**SICK**  
Sensor Intelligence.



Illustration may differ



### Ordering information

Type	Part no.
WLG4-3F2182	1028134

Other models and accessories → [www.sick.com/W4-3\\_Glass](http://www.sick.com/W4-3_Glass)

### Detailed technical data

#### Features

<b>Sensor/ detection principle</b>	Photoelectric retro-reflective sensor
<b>Dimensions (W x H x D)</b>	16 mm x 39.5 mm x 12 mm
<b>Housing design (light emission)</b>	Rectangular
<b>Sensing range max.</b>	0.01 m ... 1.6 m <sup>1)</sup>
<b>Sensing range</b>	0.02 m ... 0.9 m <sup>1)</sup>
<b>Type of light</b>	Visible red light
<b>Light source</b>	PinPoint LED <sup>2)</sup>
<b>Light spot size (distance)</b>	Ø 75 mm (1.5 m)
<b>Wave length</b>	650 nm
<b>Adjustment</b>	Single teach-in button
<b>AutoAdapt</b>	✓
<b>Special applications</b>	Detecting transparent objects
<b>Special features</b>	Without polarisation filter

<sup>1)</sup> Reflector PL80A.

<sup>2)</sup> Average service life: 100,000 h at T<sub>J</sub> = +25 °C.

## Mechanics/electronics

<b>Supply voltage</b>	10 V DC ... 30 V DC <sup>1)</sup>
<b>Ripple</b>	< 5 V <sub>pp</sub> <sup>2)</sup>
<b>Power consumption</b>	20 mA <sup>3)</sup>
<b>Switching output</b>	PNP
<b>Switching mode</b>	Dark switching
<b>Output current I<sub>max.</sub></b>	≤ 100 mA
<b>Response time</b>	< 0.5 ms <sup>4)</sup>
<b>Switching frequency</b>	1,000 Hz <sup>5)</sup>
<b>Angle of reception</b>	Approx. 30°
<b>Attenuation along light beam</b>	> 8 %
<b>Connection type</b>	Connector M8, 3-pin
<b>Circuit protection</b>	A <sup>6)</sup> C <sup>7)</sup> D <sup>8)</sup>
<b>Protection class</b>	III
<b>Weight</b>	30 g
<b>Housing material</b>	Plastic, ABS
<b>Optics material</b>	Plastic, PMMA
<b>Enclosure rating</b>	IP67 IP66
<b>Special feature</b>	Detecting transparent objects
<b>Ambient operating temperature</b>	-40 °C ... +60 °C
<b>Ambient storage temperature</b>	-40 °C ... +75 °C

<sup>1)</sup> Limit values.

<sup>2)</sup> May not exceed or fall below U<sub>v</sub> tolerances.

<sup>3)</sup> Without load.

<sup>4)</sup> Signal transit time with resistive load.

<sup>5)</sup> With light/dark ratio 1:1.

<sup>6)</sup> A = V<sub>S</sub> connections reverse-polarity protected.

<sup>7)</sup> C = interference suppression.

<sup>8)</sup> D = outputs overcurrent and short-circuit protected.

## Classifications

<b>ECl@ss 5.0</b>	27270902
<b>ECl@ss 5.1.4</b>	27270902
<b>ECl@ss 6.0</b>	27270902
<b>ECl@ss 6.2</b>	27270902
<b>ECl@ss 7.0</b>	27270902
<b>ECl@ss 8.0</b>	27270902
<b>ECl@ss 8.1</b>	27270902
<b>ECl@ss 9.0</b>	27270902
<b>ETIM 5.0</b>	EC002717
<b>ETIM 6.0</b>	EC002717

UNSPSC 16.0901

39121528

**Connection diagram**

Cd-045

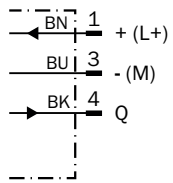

**Characteristic curve**

WLG4-3 without polarisation filter

Operating reserve

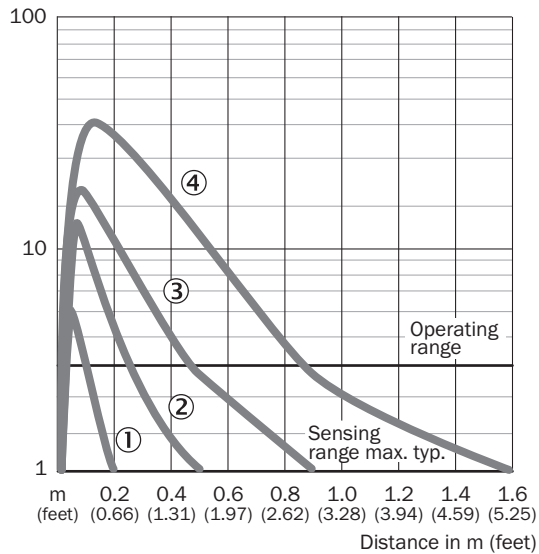

- ① PL10F reflector
- ② Reflector PL20A
- ③ Reflector PL40A
- ④ Reflector PL80A

## Sensing range diagram

WLG4-3 without polarisation filter

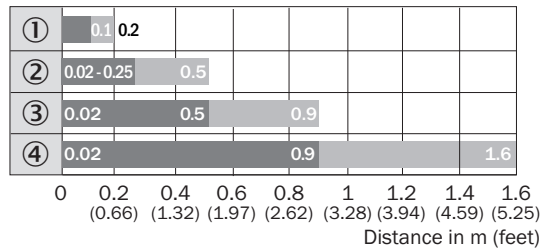

■ Sensing range      ■ Sensing range max.

- ① PL10F reflector
- ② Reflector PL20A
- ③ Reflector PL40A
- ④ Reflector PL80A

## Modified teach mode

### Geänderter Teach Modus modified teach mode WLG4-3

Bitte neuen Teach-In-Mode ab Herstellungswoche  
**01/2013** berücksichtigen.

Teach-In-Taste drücken:

- **2 Sek.** für transparente Objekte (8% Schaltschwelle mit autom. Nachführung)
- **8 Sek.** für Standardanwendungen (Schaltschwelle 50%)

Teach-In-Mode **vor** Herstellungswoche **01/2013**

Teach-In-Taste drücken:

- **2 Sek.** (50% Schaltschwelle ohne Nachführung)
- **8 Sek.** für transparente Objekte (Schaltschwelle 10%)

Please consider new teach-in mode as of  
production week **01/2013**.

Press teach-in button:

- **2 sec.** for clear objects (8% threshold with continuous threshold adaption)
- **8 sec.** for standard mode (50% threshold)

Teach-In-Mode **before** production week **01/2013**.

Press teach-in button:

- **2 sec.** (50% threshold without continuous threshold adaption)
- **8 sec.** for clear objects (threshold 10%)

Bsp. Herstellungswoche 1309 = KW09/2013  
eg production week 1309 = CW09/2013



**SICK**  
Sensor Intelligence.

**Dimensional drawing** (Dimensions in mm (inch))



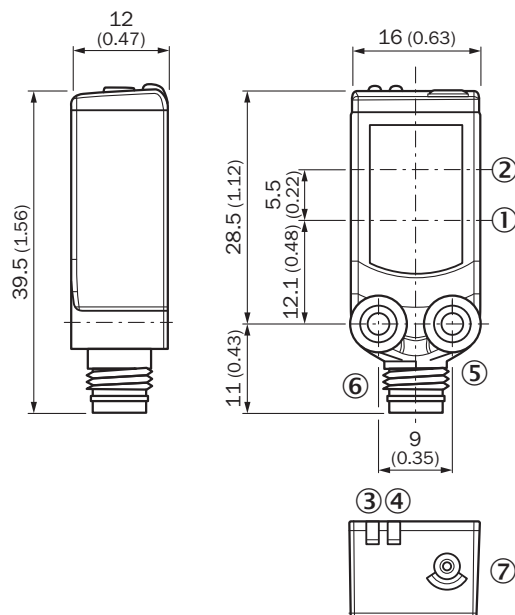

WLG4-3



- ① Center of optical axis, sender
- ② Center of optical axis, receiver
- ③ Orange LED indicator: status of received light beam
- ④ LED indicator green: Supply voltage active
- ⑤ Threaded mounting hole M3
- ⑥ Connection
- ⑦ Teach-in button

**Recommended accessories**

Other models and accessories → [www.sick.com/W4-3\\_Glass](http://www.sick.com/W4-3_Glass)

	<b>Brief description</b>	<b>Type</b>	<b>Part no.</b>
<b>Universal bar clamp systems</b>			
	Plate N08 for universal clamp bracket, Zinc plated steel (sheet), Zinc die cast (clamping bracket), Universal clamp (5322626), mounting hardware	BEF-KHS-N08	2051607
<b>Mounting brackets and plates</b>			
	Universal mounting bracket for reflectors, steel, zinc coated	BEF-WN-REFX	2064574
<b>Plug connectors and cables</b>			
	Head A: female connector, M8, 3-pin, straight, A-coded Head B: Flying leads Cable: Sensor/actuator cable, PVC, unshielded, 5 m	YF8U13-050VA1XLEAX	2095884
	Head A: male connector, M8, 3-pin, straight Head B: - Cable: unshielded	STE-0803-G	6037322

## SICK AT A GLANCE

SICK is one of the leading manufacturers of intelligent sensors and sensor solutions for industrial applications. A unique range of products and services creates the perfect basis for controlling processes securely and efficiently, protecting individuals from accidents and preventing damage to the environment.

We have extensive experience in a wide range of industries and understand their processes and requirements. With intelligent sensors, we can deliver exactly what our customers need. In application centers in Europe, Asia and North America, system solutions are tested and optimized in accordance with customer specifications. All this makes us a reliable supplier and development partner.

Comprehensive services complete our offering: SICK LifeTime Services provide support throughout the machine life cycle and ensure safety and productivity.

For us, that is “Sensor Intelligence.”

## WORLDWIDE PRESENCE:

Contacts and other locations –[www.sick.com](http://www.sick.com)