



WLG4-3F2234

W4-3 Glass

MINIATURE PHOTOELECTRIC SENSORS

SICK
Sensor Intelligence.



Illustration may differ



Ordering information

| Type | Part no. |
|-------------|----------|
| WLG4-3F2234 | 1028130 |

Other models and accessories → www.sick.com/W4-3_Glass

Detailed technical data

Features

| | |
|--|---------------------------------------|
| Sensor/ detection principle | Photoelectric retro-reflective sensor |
| Dimensions (W x H x D) | 16 mm x 39.5 mm x 12 mm |
| Housing design (light emission) | Rectangular |
| Sensing range max. | 0.01 m ... 4.5 m ¹⁾ |
| Sensing range | 0.02 m ... 3.5 m ¹⁾ |
| Type of light | Visible red light |
| Light source | PinPoint LED ²⁾ |
| Light spot size (distance) | Ø 75 mm (1.5 m) |
| Wave length | 650 nm |
| Adjustment | Cable Single teach-in button |
| AutoAdapt | ✓ |
| Special applications | Detecting transparent objects |

¹⁾ Reflector PL80A.

²⁾ Average service life: 100,000 h at T_U = +25 °C.

Mechanics/electronics

| | |
|---------------------------------------|---|
| Supply voltage | 10 V DC ... 30 V DC ¹⁾ |
| Ripple | < 5 V _{pp} ²⁾ |
| Power consumption | 20 mA ³⁾ |
| Switching output | PNP |
| Switching mode | Dark switching |
| Output current I_{max} | ≤ 100 mA |
| Response time | < 0.5 ms ⁴⁾ |
| Switching frequency | 1,000 Hz ⁵⁾ |
| Angle of reception | Approx. 30° |
| Attenuation along light beam | > 8 % |
| Connection type | Male connector M8, 4-pin |
| Circuit protection | A ⁶⁾ C ⁷⁾ D ⁸⁾ |
| Protection class | III |
| Weight | 30 g |
| Polarisation filter | ✓ |
| Housing material | Plastic, ABS |
| Optics material | Plastic, PMMA |
| Enclosure rating | IP67 IP66 |
| Special feature | Detecting transparent objects |
| Ambient operating temperature | -40 °C ... +60 °C |
| Ambient storage temperature | -40 °C ... +75 °C |

¹⁾ Limit values.

²⁾ May not exceed or fall below U_v tolerances.

³⁾ Without load.

⁴⁾ Signal transit time with resistive load.

⁵⁾ With light/dark ratio 1:1.

⁶⁾ A = V_S connections reverse-polarity protected.

⁷⁾ C = interference suppression.

⁸⁾ D = outputs overcurrent and short-circuit protected.

Classifications

| | |
|---------------------|----------|
| ECl@ss 5.0 | 27270902 |
| ECl@ss 5.1.4 | 27270902 |
| ECl@ss 6.0 | 27270902 |
| ECl@ss 6.2 | 27270902 |
| ECl@ss 7.0 | 27270902 |
| ECl@ss 8.0 | 27270902 |
| ECl@ss 8.1 | 27270902 |
| ECl@ss 9.0 | 27270902 |
| ETIM 5.0 | EC002717 |

| | |
|-----------------------|----------|
| ETIM 6.0 | EC002717 |
| UNSPSC 16.0901 | 39121528 |

Connection diagram

Cd-092

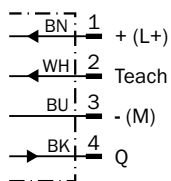

Characteristic curve

WLG4-3 with polarisation filter

Operating reserve in %

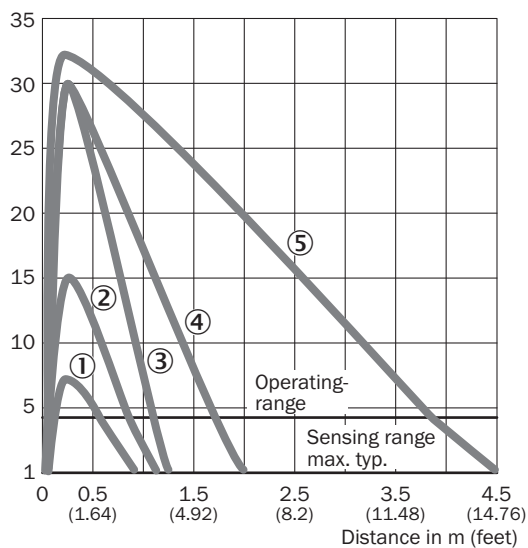

- ① Reflective tape REF-IRF-56
- ② PL10F reflector
- ③ Reflector PL20A
- ④ Reflector PL40A
- ⑤ Reflector PL80A

Sensing range diagram

WLG4-3 with polarisation filter

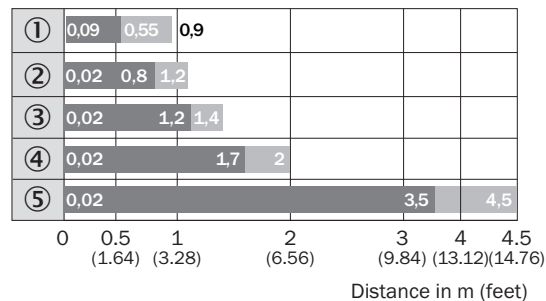

■ Sensing range ■ Sensing range max.

- ① Reflective tape REF-IRF-56
- ② PL10F reflector
- ③ Reflector PL20A
- ④ Reflector PL40A
- ⑤ Reflector PL80A

Modified teach mode

Geänderter Teach Modus modified teach mode WLG4-3

Bitte neuen Teach-In-Mode ab Herstellungswoche
01/2013 berücksichtigen.

Teach-In-Taste drücken:

- **2 Sek.** für transparente Objekte (8% Schaltschwelle mit autom. Nachführung)
- **8 Sek.** für Standardanwendungen (Schaltschwelle 50%)

Teach-In-Mode **vor** Herstellungswoche **01/2013**

Teach-In-Taste drücken:

- **2 Sek.** (50% Schaltschwelle ohne Nachführung)
- **8 Sek.** für transparente Objekte (Schaltschwelle 10%)

Please consider new teach-in mode as of
production week **01/2013**.

Press teach-in button:

- **2 sec.** for clear objects (8% threshold with continuous threshold adaption)
- **8 sec.** for standard mode (50% threshold)

Teach-In-Mode **before** production week **01/2013**.

Press teach-in button:

- **2 sec.** (50% threshold without continuous threshold adaption)
- **8 sec.** for clear objects (threshold 10%)

Bsp. Herstellungswoche 1309 = KW09/2013
eg production week 1309 = CW09/2013



SICK
Sensor Intelligence.

Dimensional drawing (Dimensions in mm (inch))



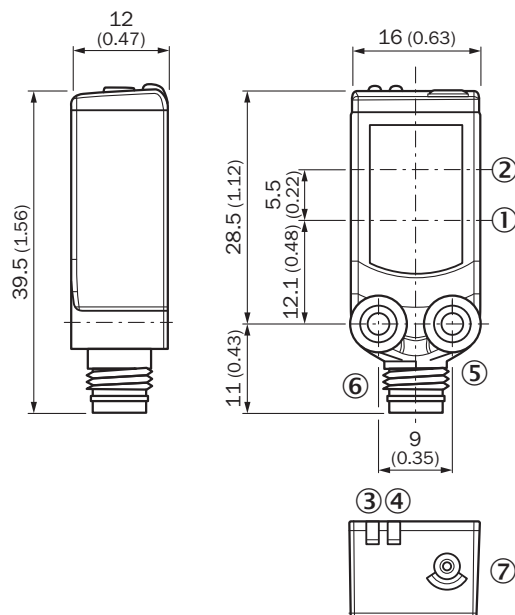

WLG4-3



- ① Center of optical axis, sender
- ② Center of optical axis, receiver
- ③ Orange LED indicator: status of received light beam
- ④ LED indicator green: Supply voltage active
- ⑤ Threaded mounting hole M3
- ⑥ Connection
- ⑦ Teach-in button

Recommended accessories

Other models and accessories → www.sick.com/W4-3_Glass

| | Brief description | Type | Part no. |
|---|--|--------------------|-----------------|
| Universal bar clamp systems | | | |
|  | Plate N08 for universal clamp bracket, Zinc plated steel (sheet), Zinc die cast (clamping bracket), Universal clamp (5322626), mounting hardware | BEF-KHS-N08 | 2051607 |
| Mounting brackets and plates | | | |
|  | Universal mounting bracket for reflectors, steel, zinc coated | BEF-WN-REFX | 2064574 |
| Plug connectors and cables | | | |
|  | Head A: female connector, M8, 4-pin, straight, A-coded Head B: Flying leads Cable: Sensor/actuator cable, PVC, unshielded, 5 m | YF8U14-050VA3XLEAX | 2095889 |
|  | Head A: male connector, M8, 4-pin, straight Head B: - Cable: unshielded | STE-0804-G | 6037323 |

SICK AT A GLANCE

SICK is one of the leading manufacturers of intelligent sensors and sensor solutions for industrial applications. A unique range of products and services creates the perfect basis for controlling processes securely and efficiently, protecting individuals from accidents and preventing damage to the environment.

We have extensive experience in a wide range of industries and understand their processes and requirements. With intelligent sensors, we can deliver exactly what our customers need. In application centers in Europe, Asia and North America, system solutions are tested and optimized in accordance with customer specifications. All this makes us a reliable supplier and development partner.

Comprehensive services complete our offering: SICK LifeTime Services provide support throughout the machine life cycle and ensure safety and productivity.

For us, that is “Sensor Intelligence.”

WORLDWIDE PRESENCE:

Contacts and other locations –www.sick.com